

SCHULTENHOF VOORGEVEL BESTAAND

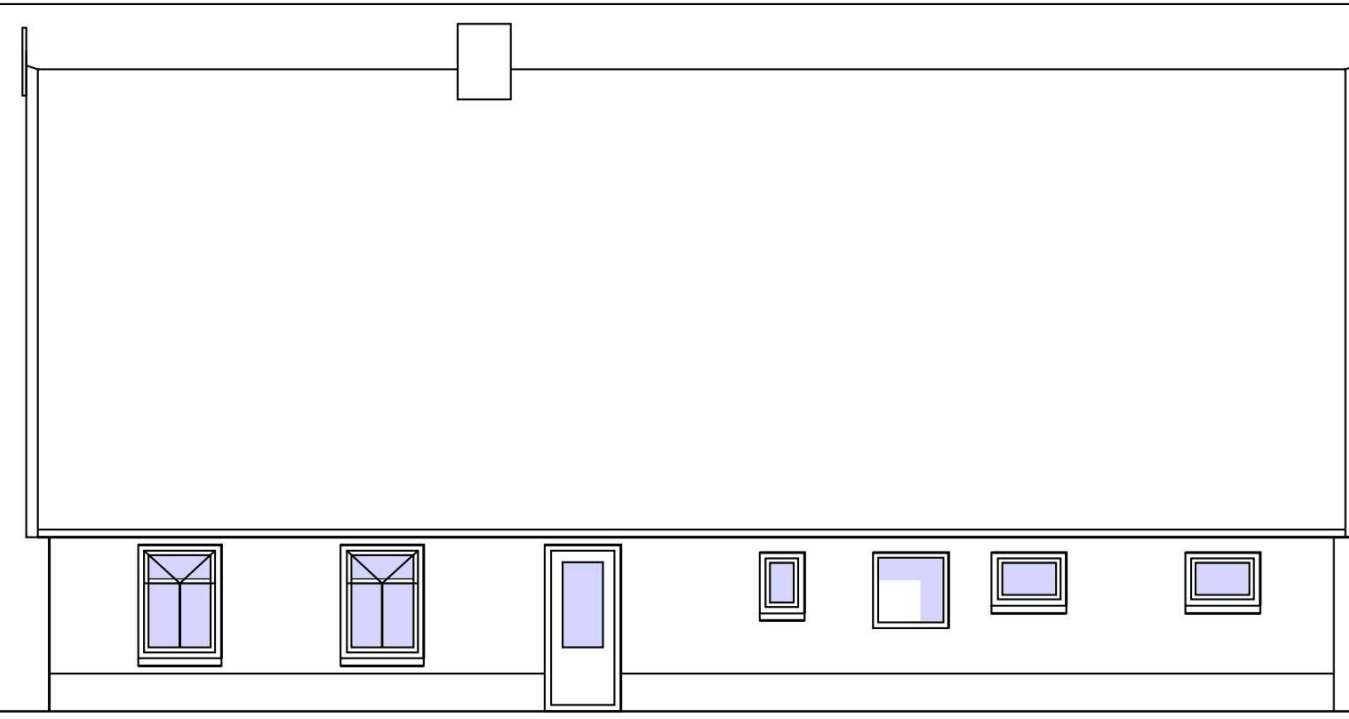

RECHTER ZIJGEVEL BESTAAND

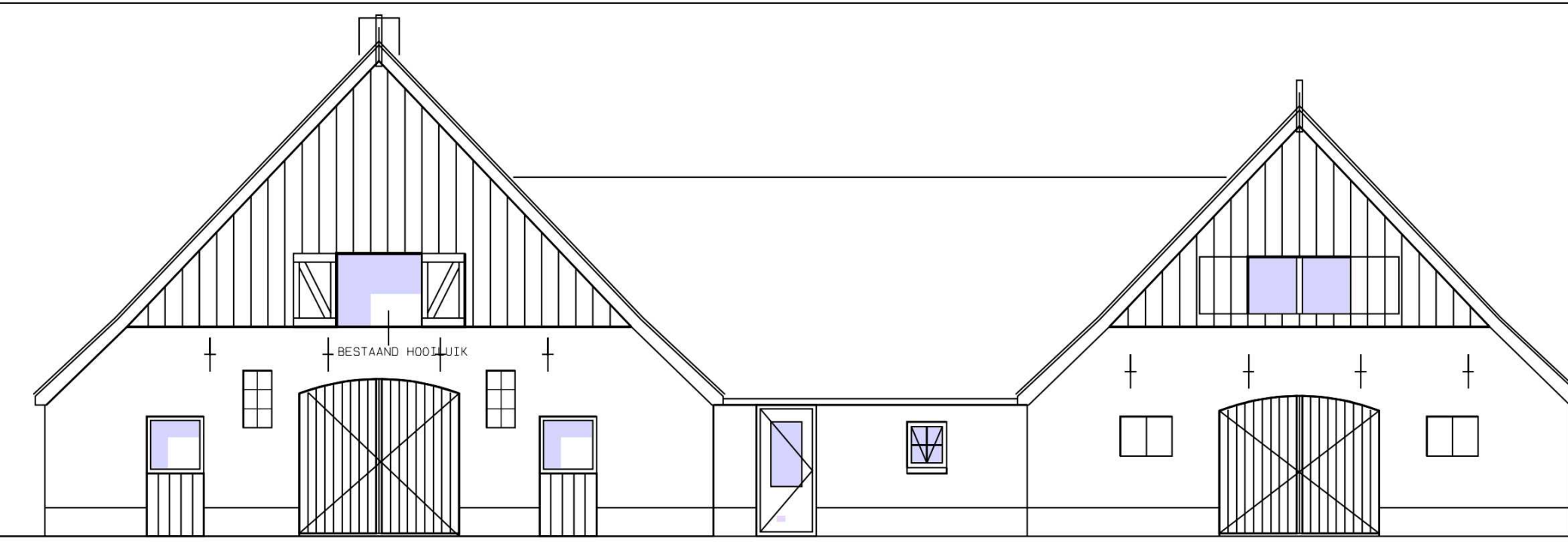

SCHULTENHOF ACHTERGEVEL BESTAAND

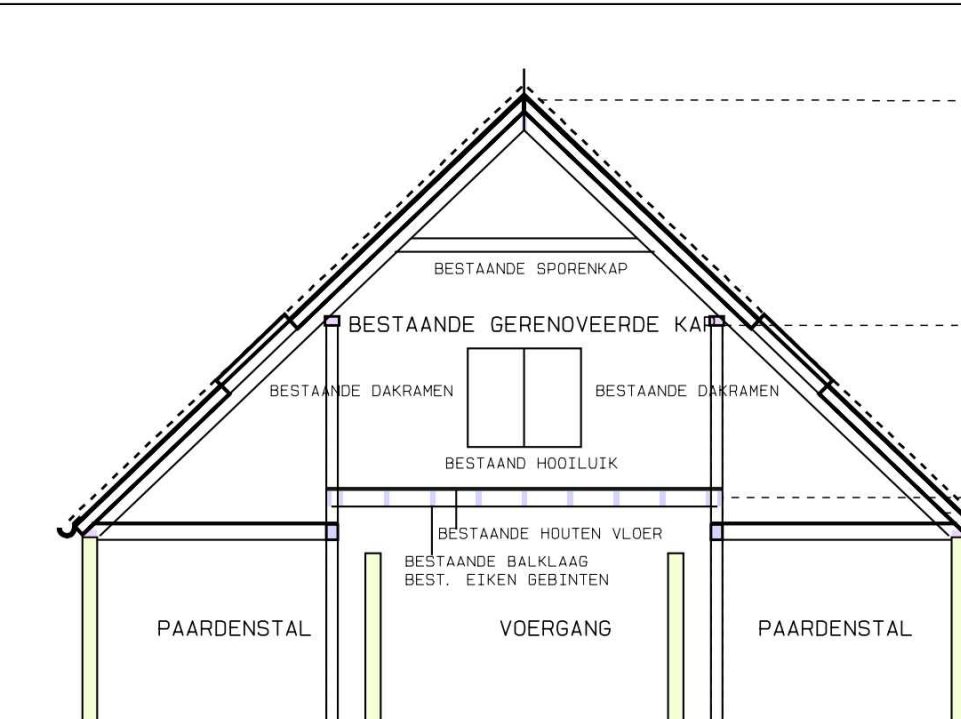

DWARSDOORSNEDE AB-AB

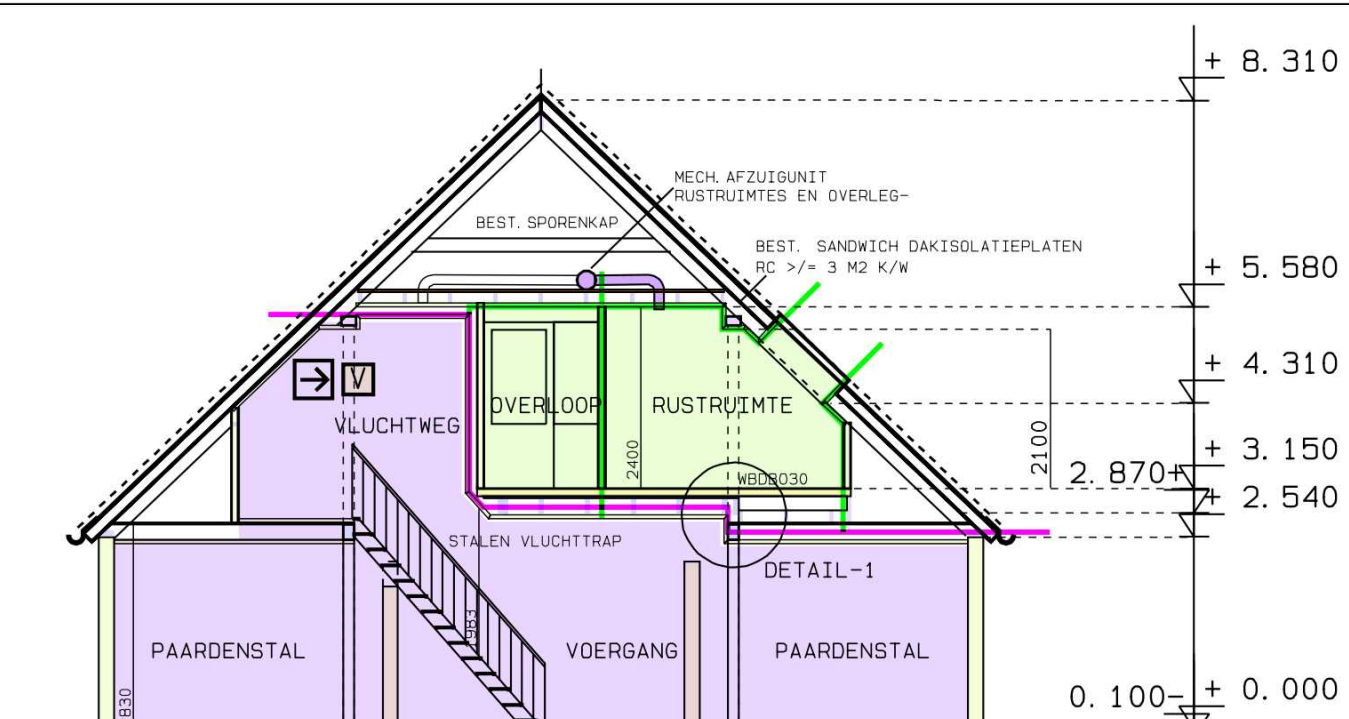

DWARSDOORSNEDE AG-AG

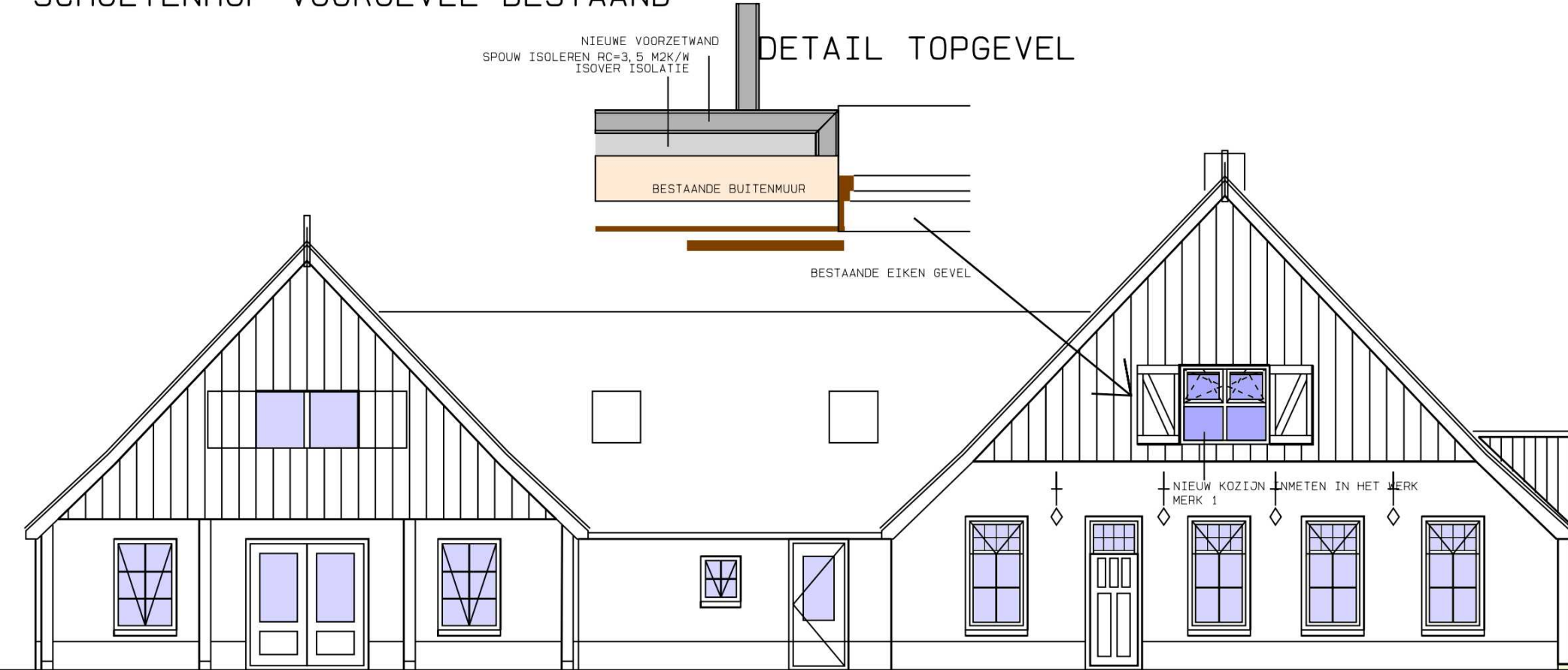

SCHULTENHOF VOORGEVEL GEWIJZIGD

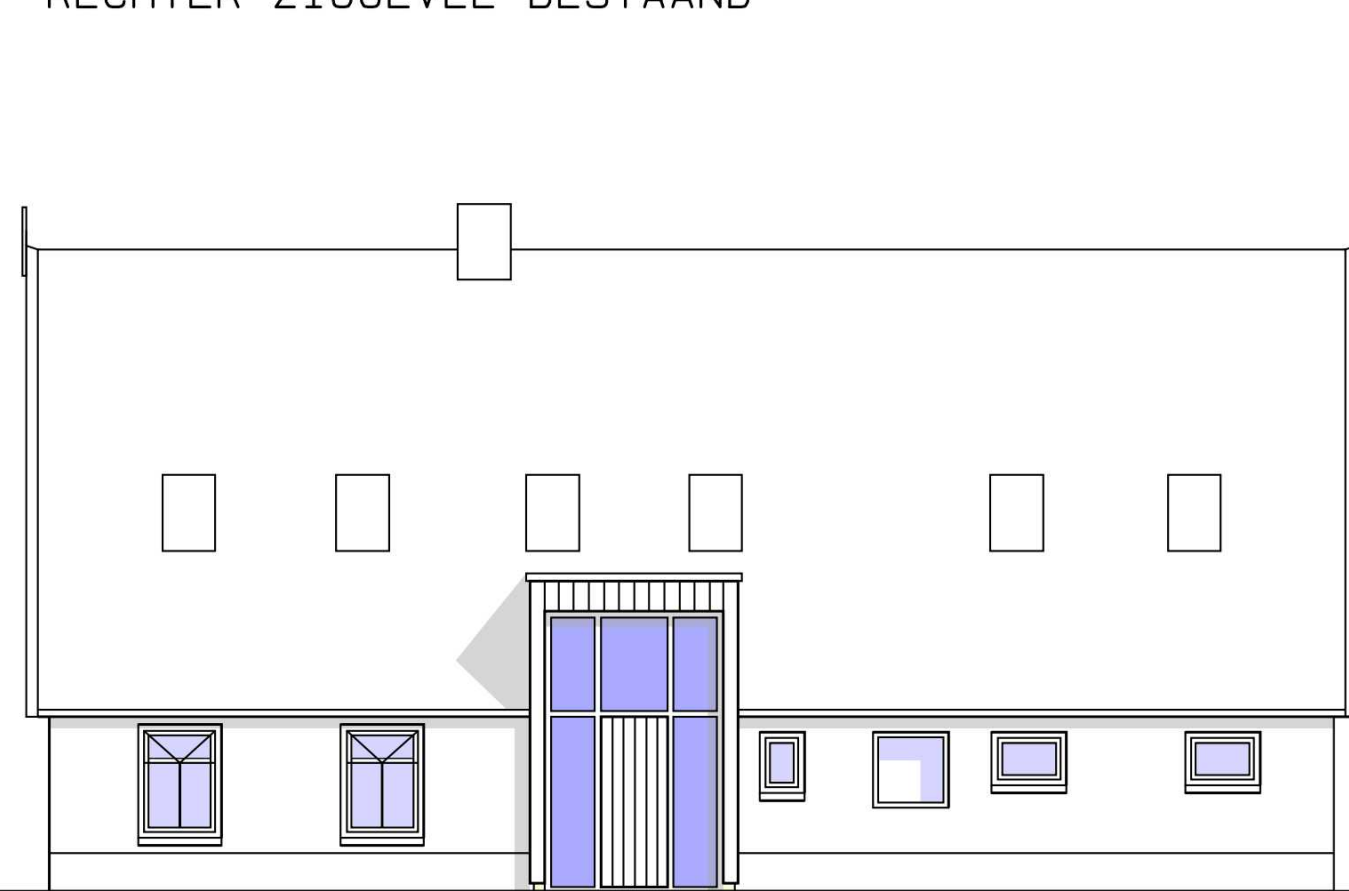

RECHTER ZIJGEVEL GEWIJZIGD



SCHULTENHOF ACHTERGEVEL GEWIJZIGD

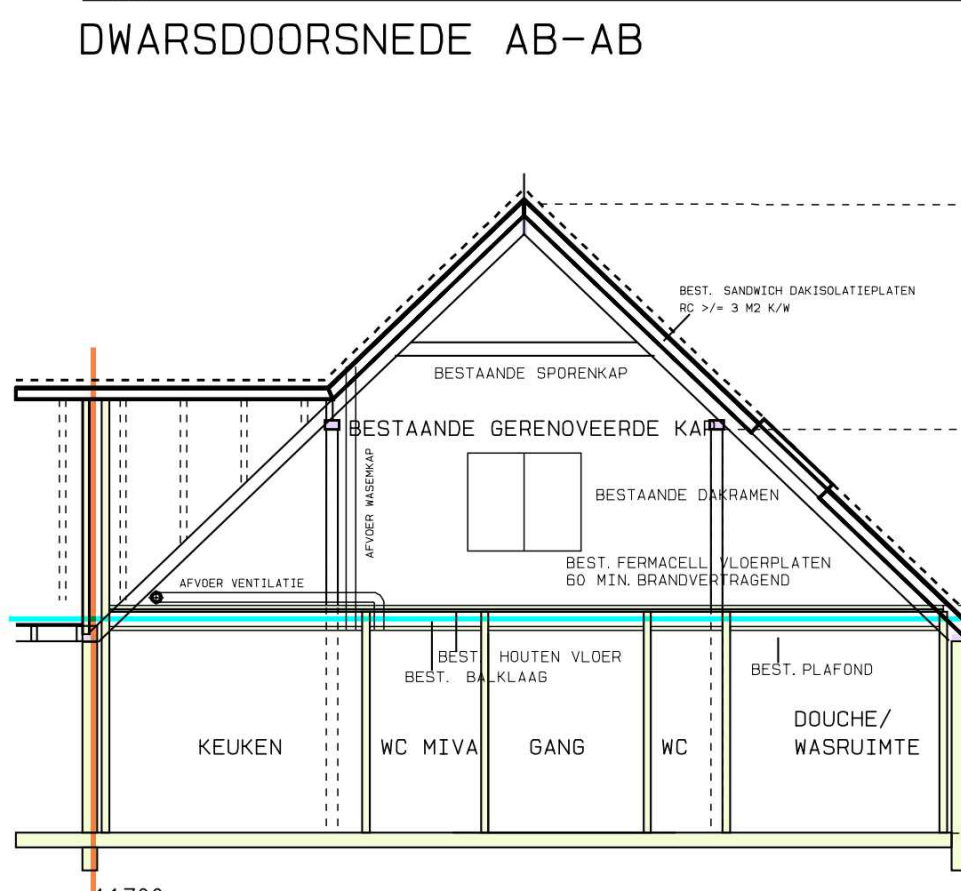

DWARSDOORSNEDE BB-BB

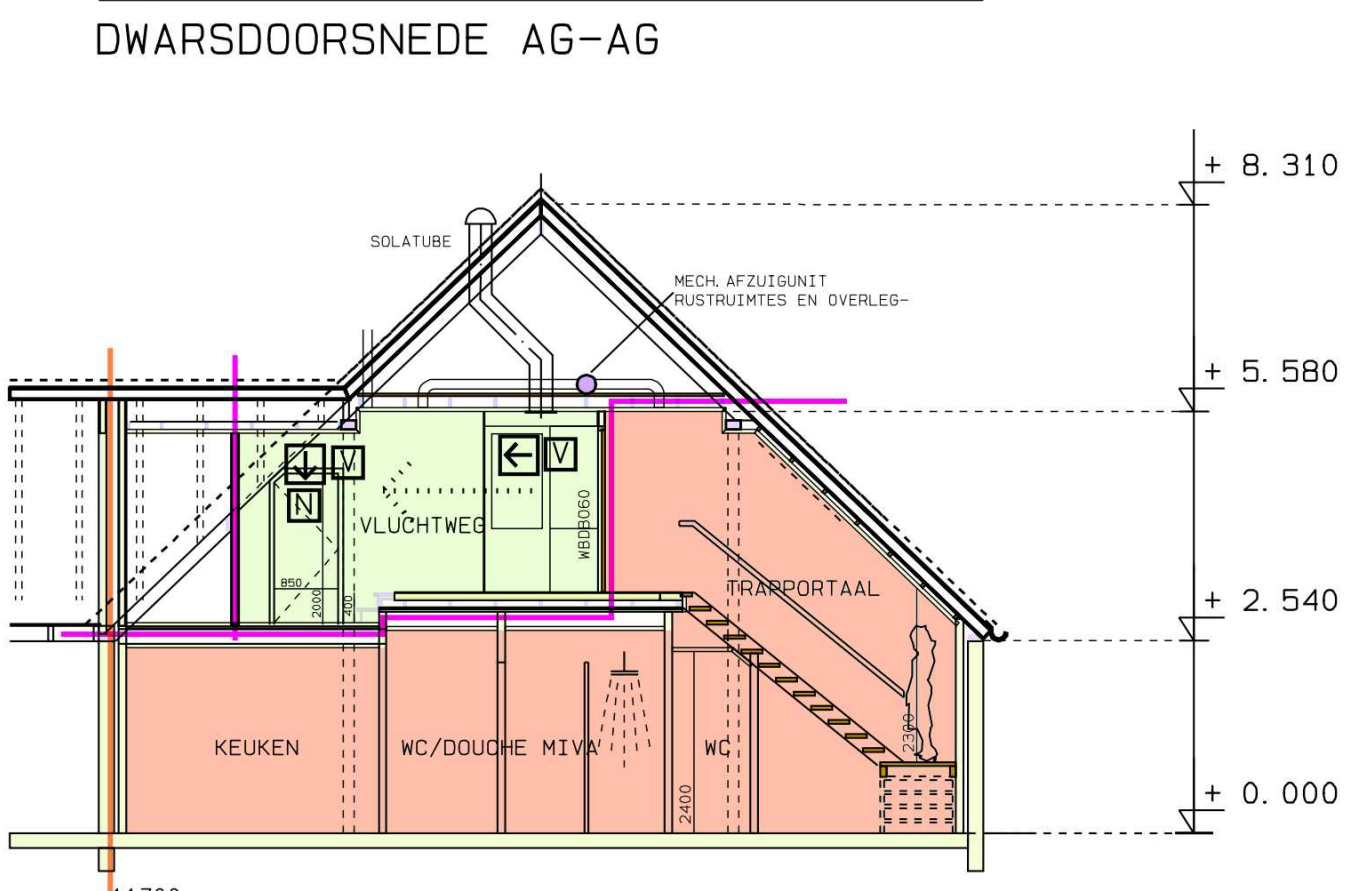

DWARSDOORSNEDE BG-BG

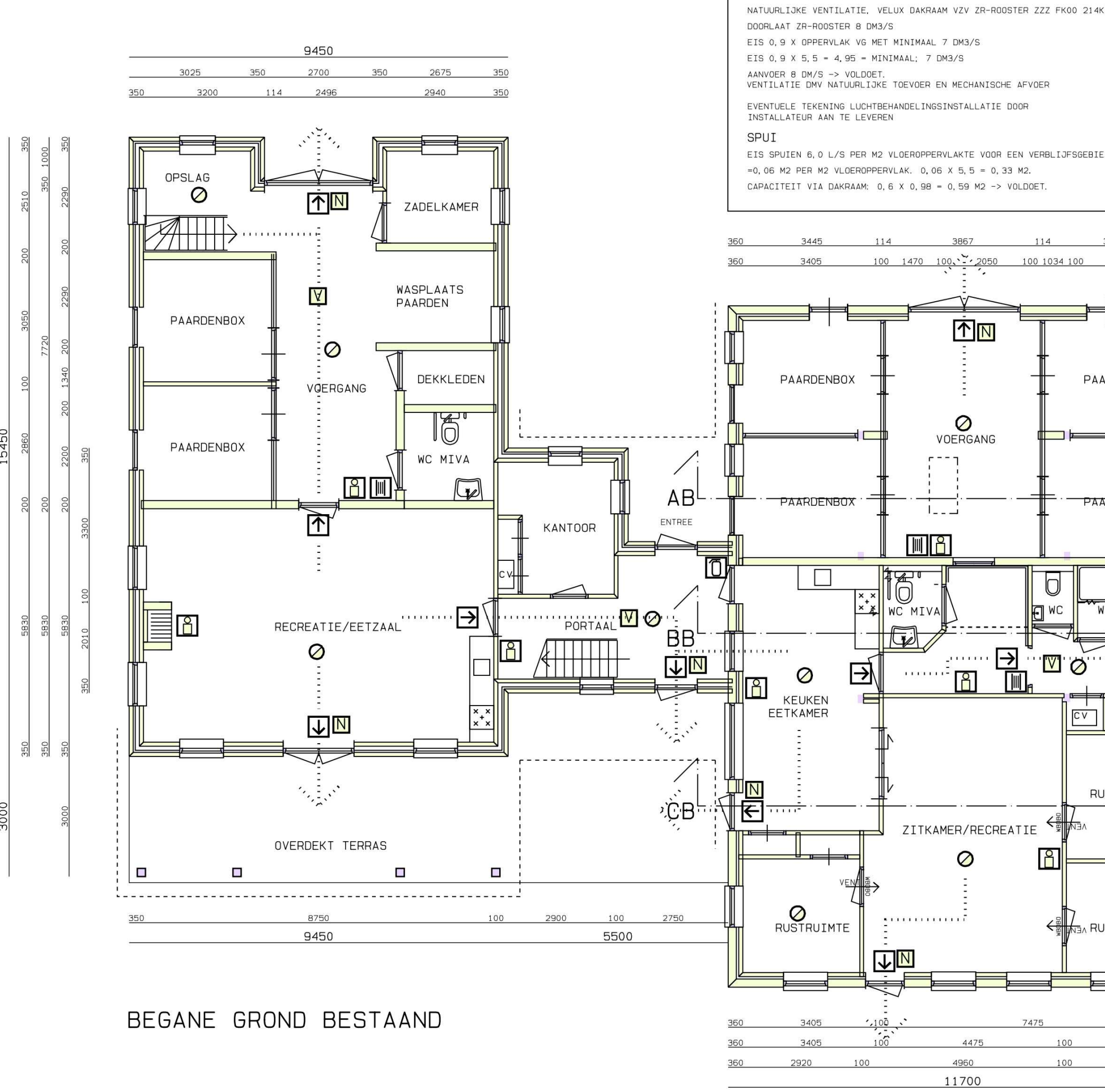

BEGANE GROND BESTAAND

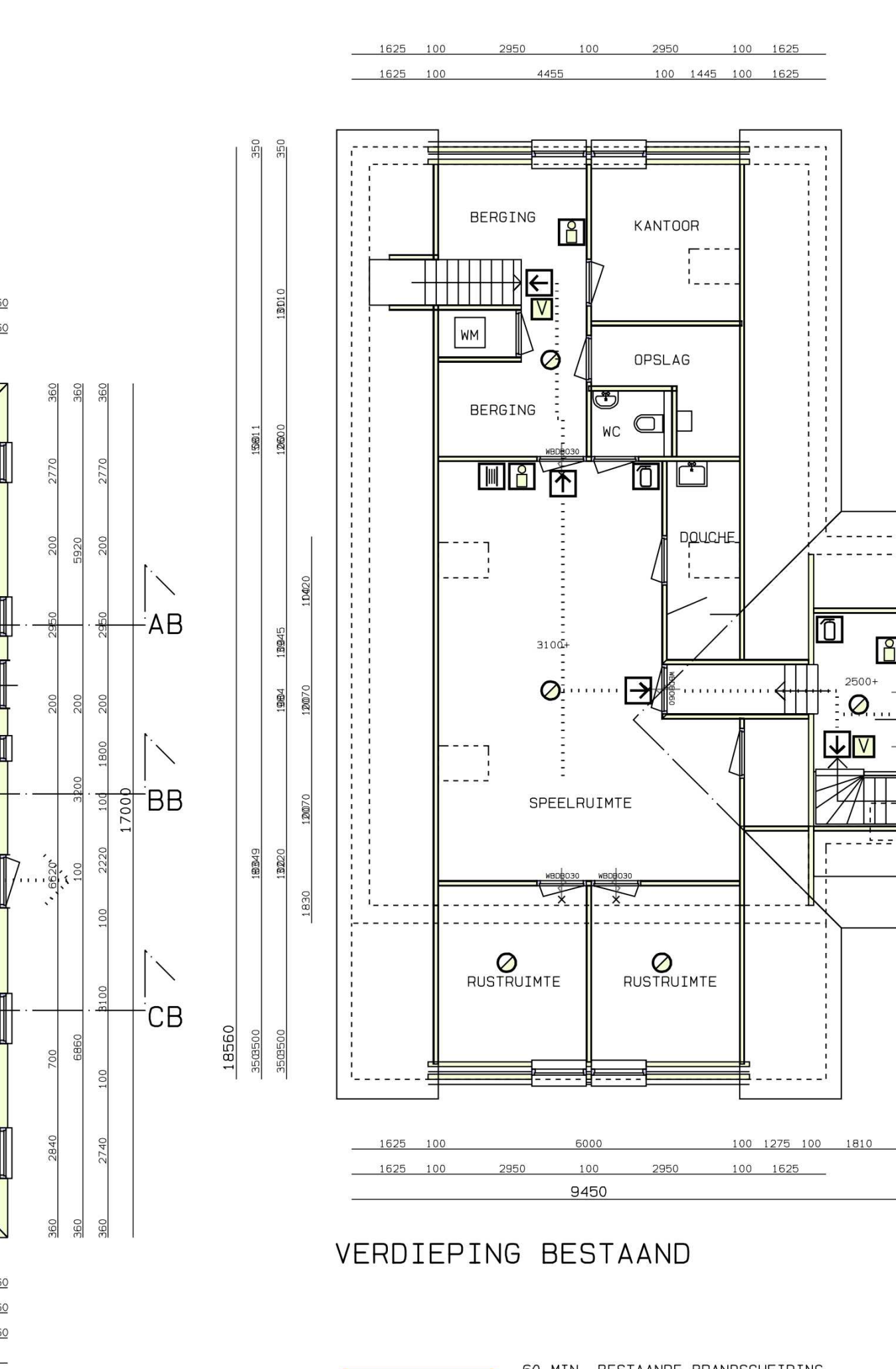

VERDIEPING BESTAAND

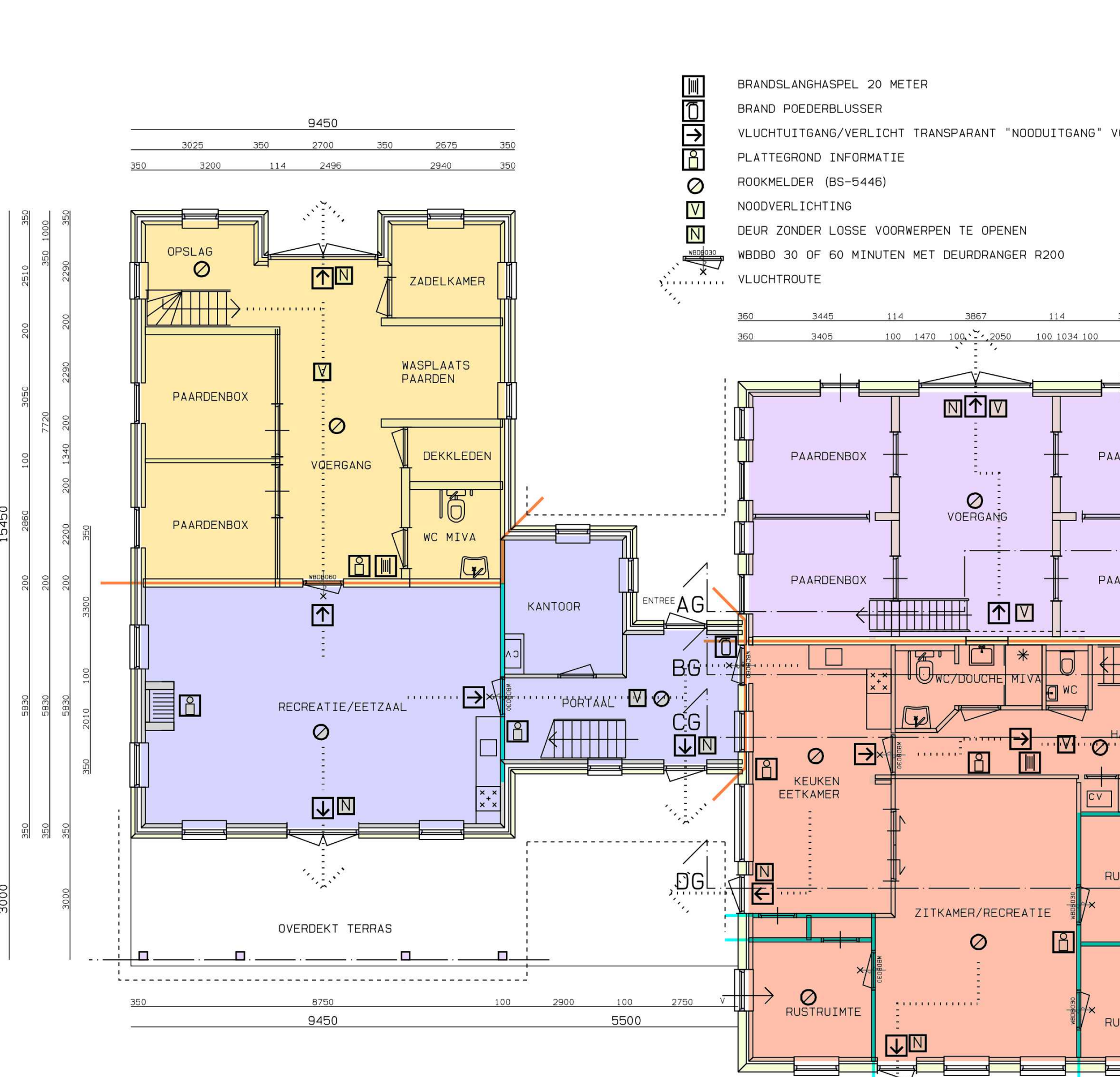
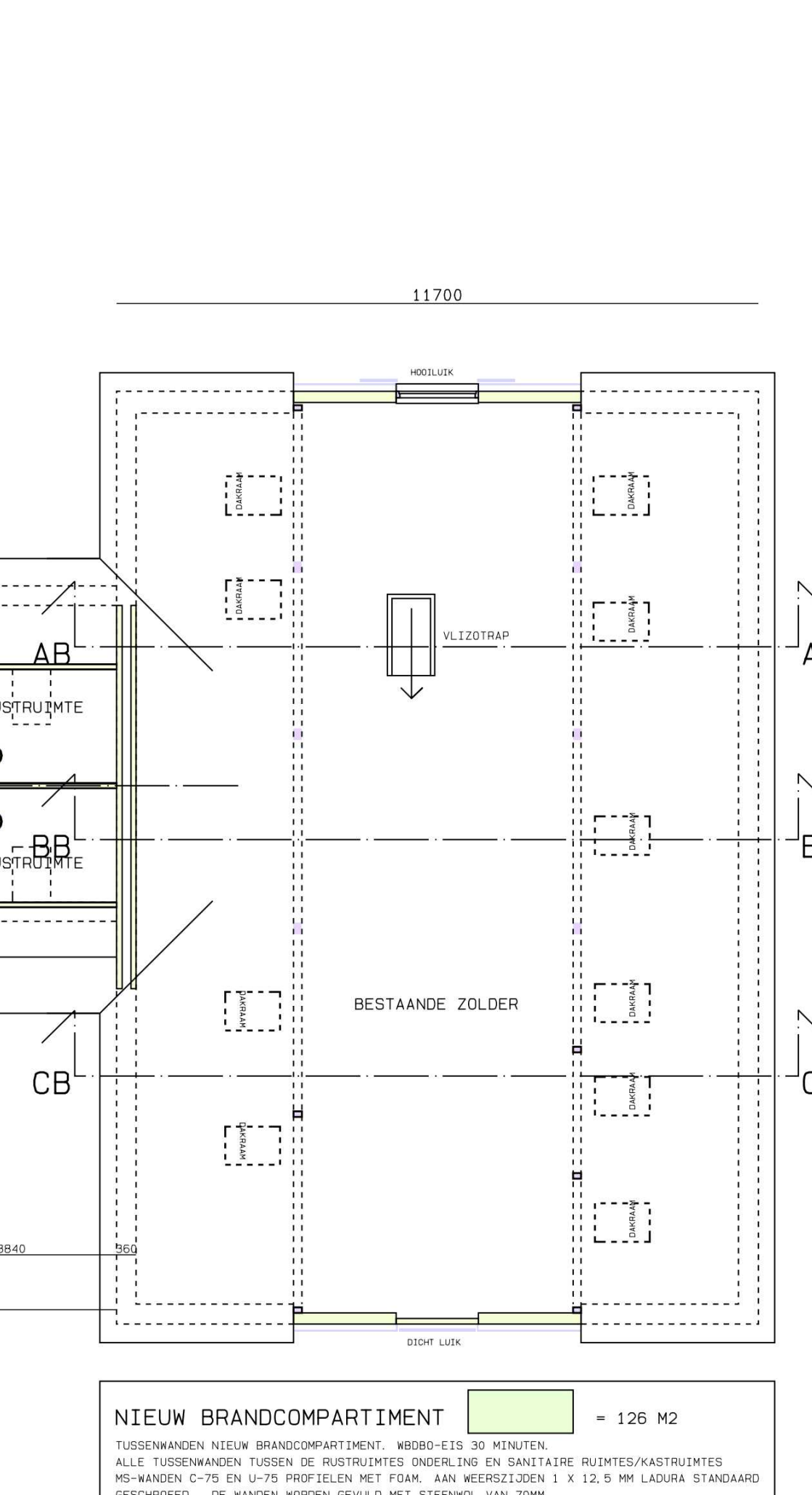

BEGANE GROND GEWIJZIGD

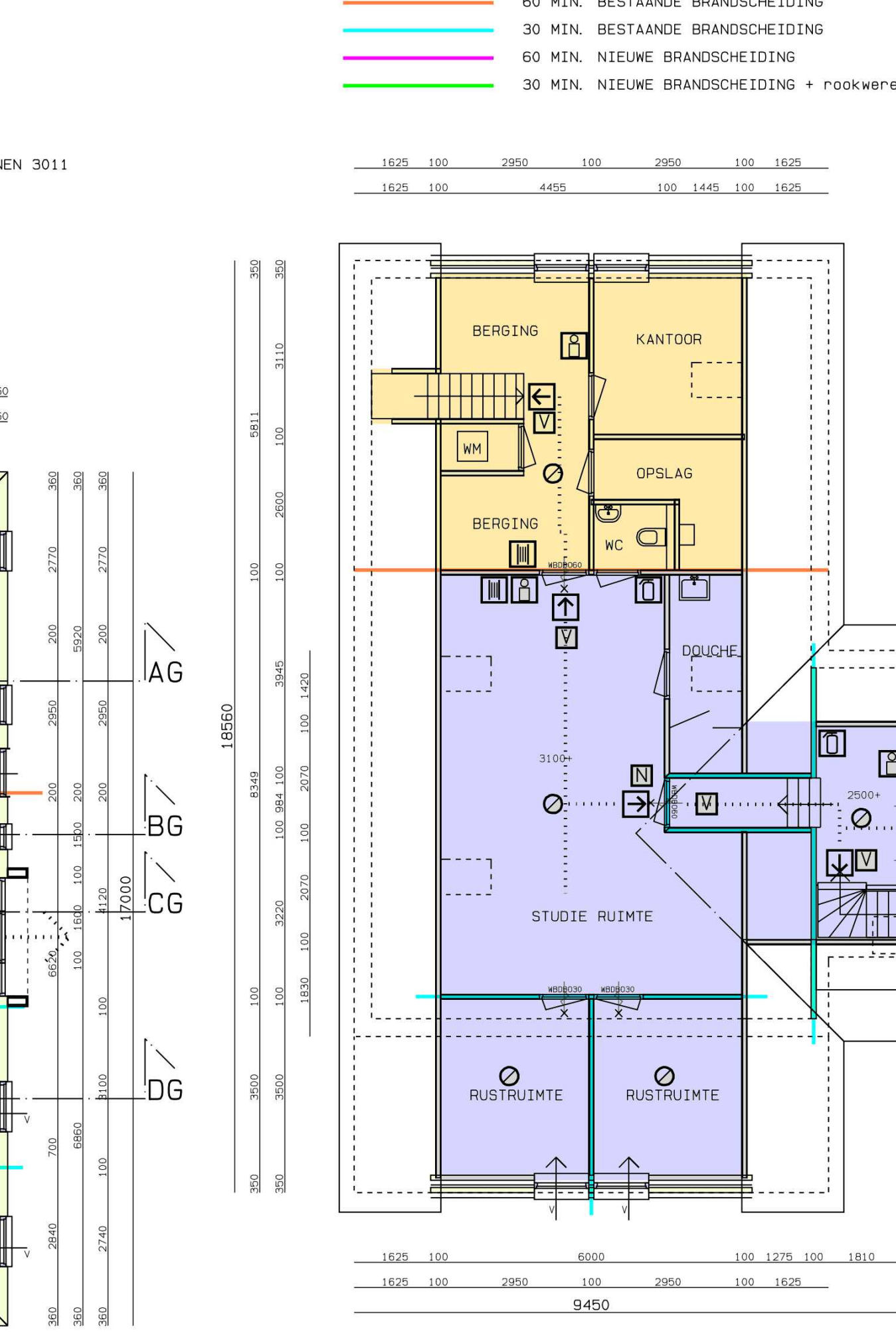

VERDIEPING GEWIJZIGD

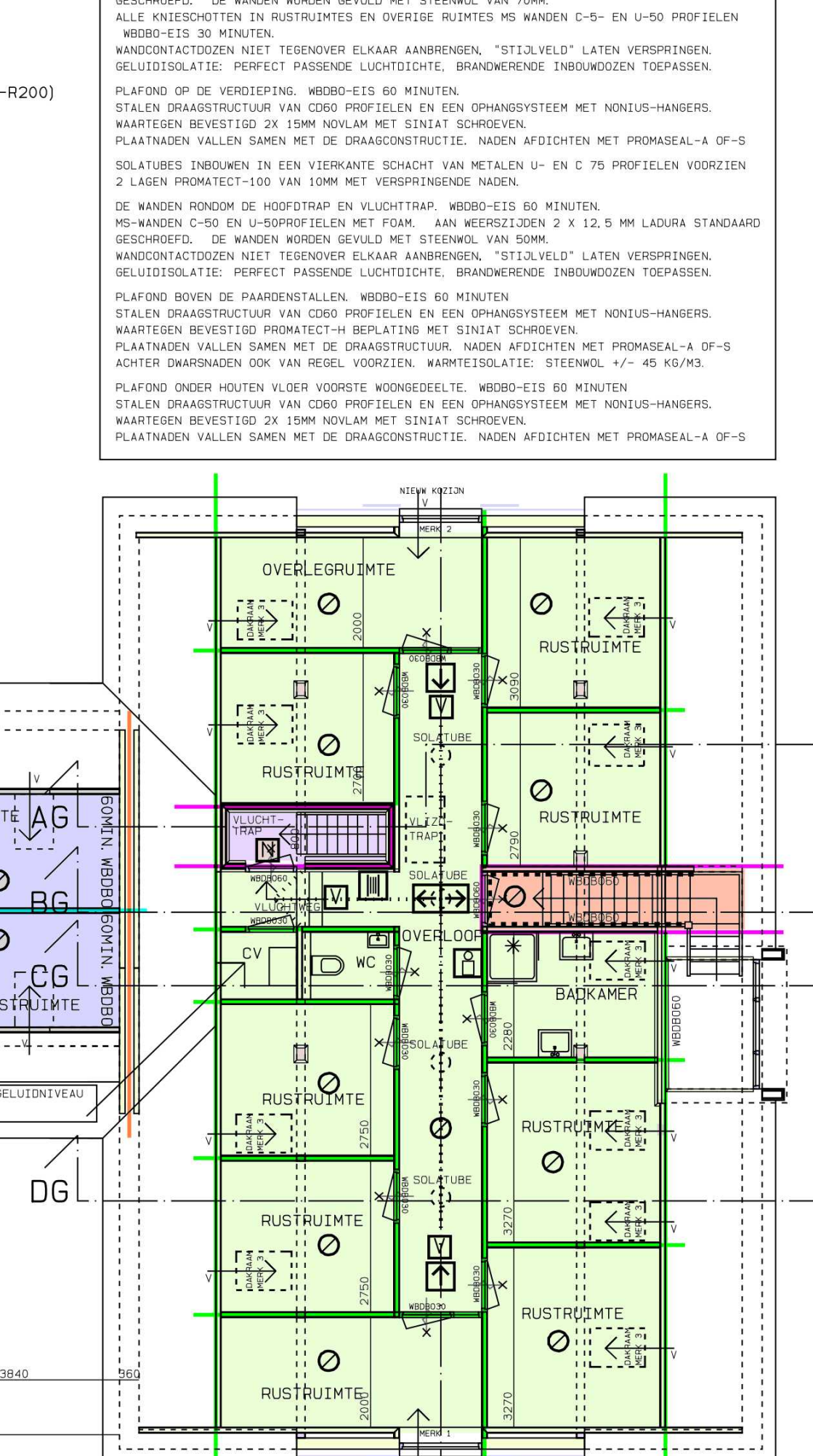

BEGANE GROND GEWIJZIGD

BESTAANDE CONSTRUCTIE

ALGEMEEN
AL MET NIET IN BESTAANDE DEEL...
BRANDSCHIEDING...
VENTILATIE...
WATERDICHHEID...

DETAIL-1 ZOLDERVLOER

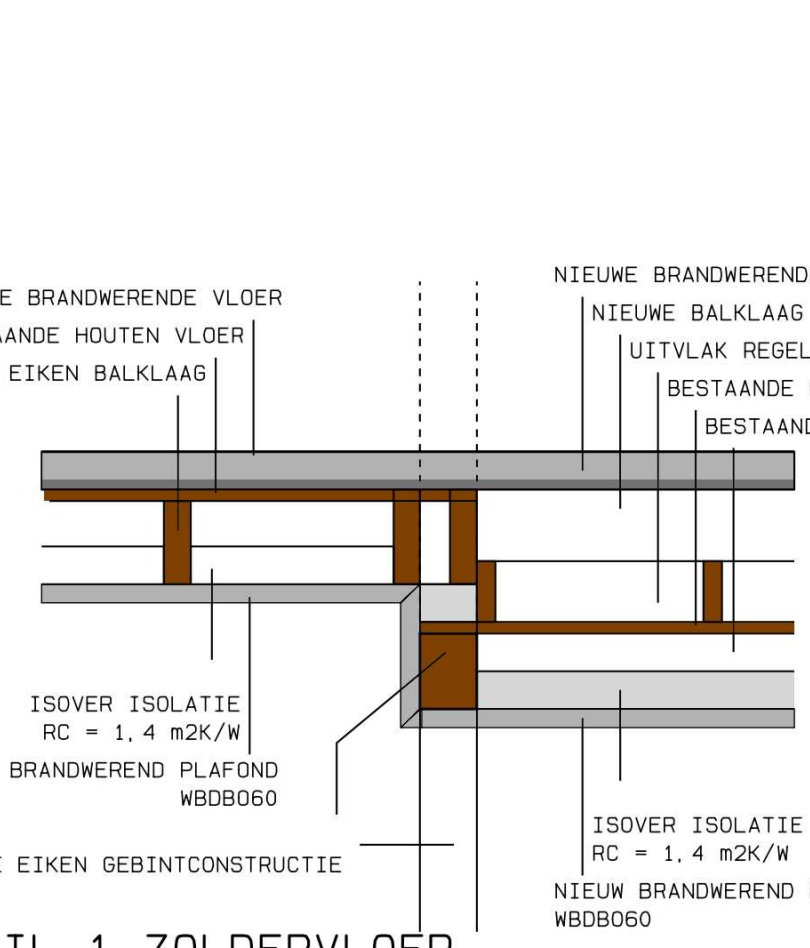

DETAIL-2 ZOLDERVLOER

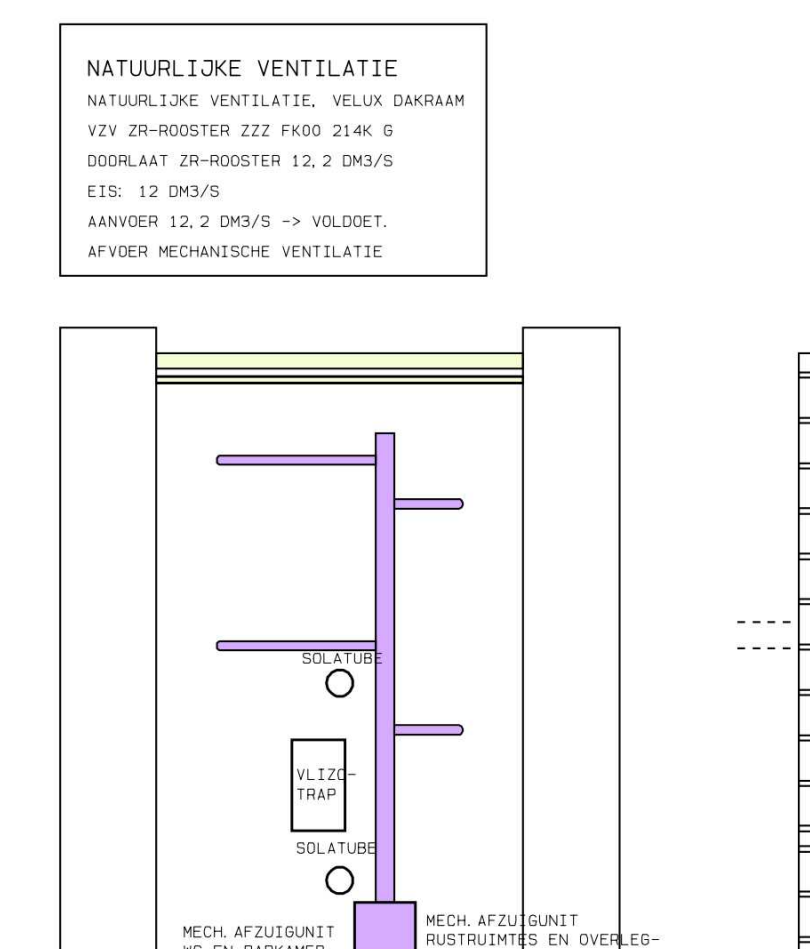

DETAIL-3 KAPCONSTRUCTIE

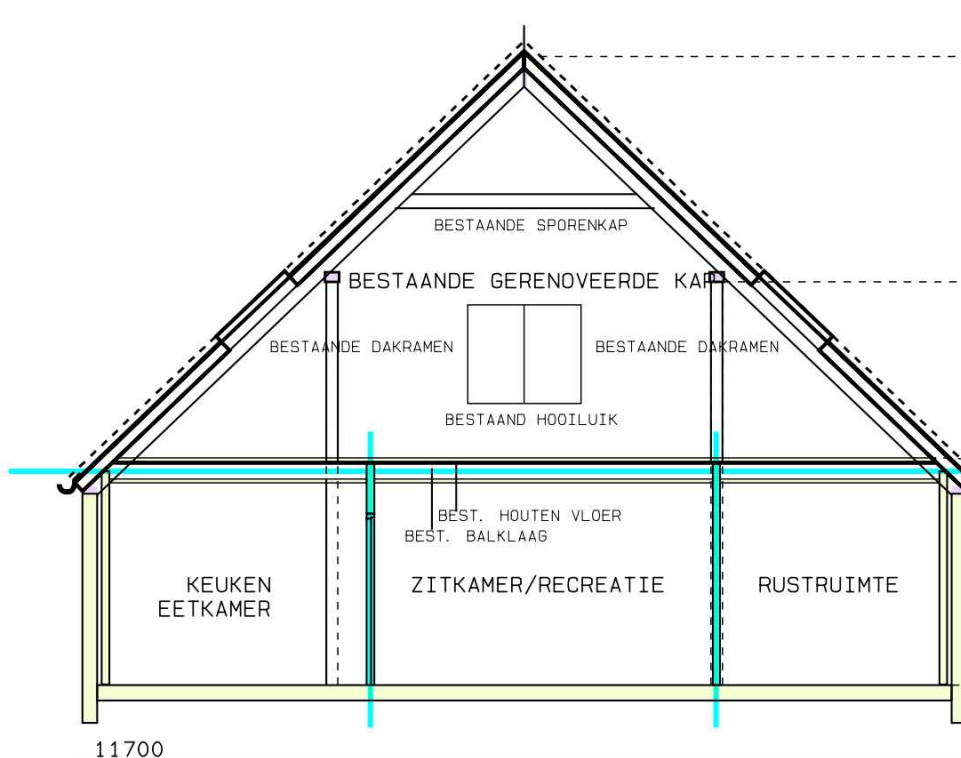
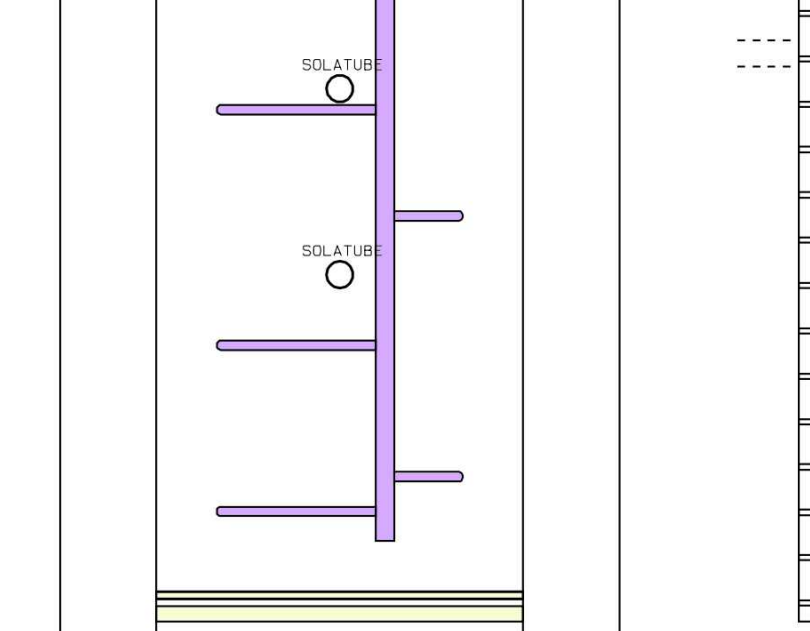

DWARSDOORSNEDE CB-CB

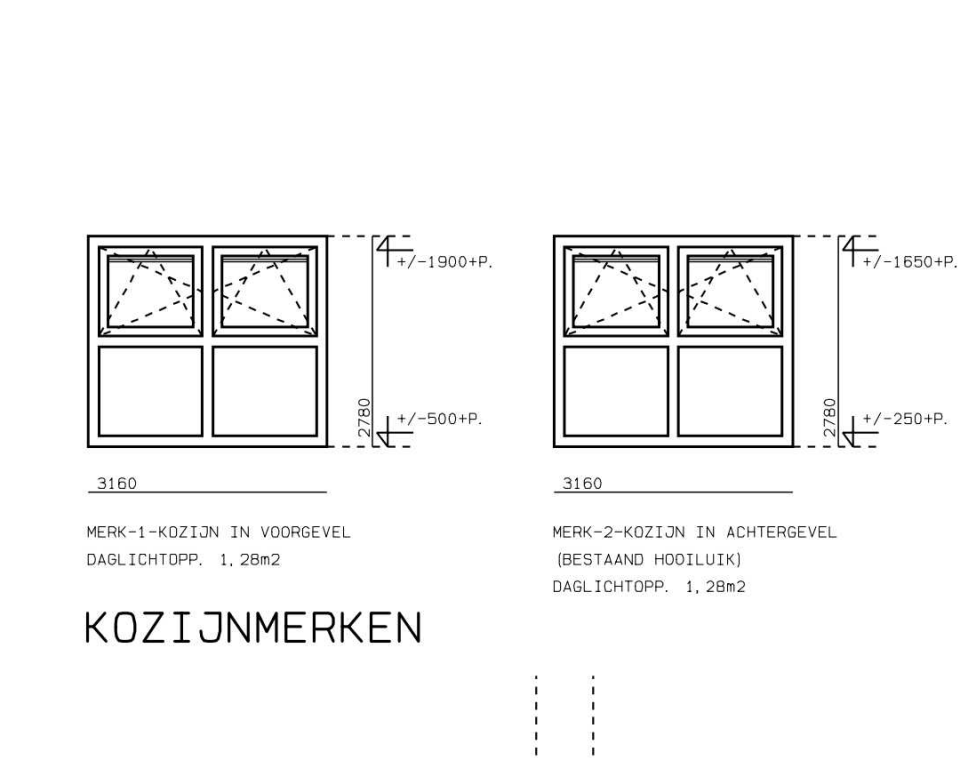

DWARSDOORSNEDE CG-CG

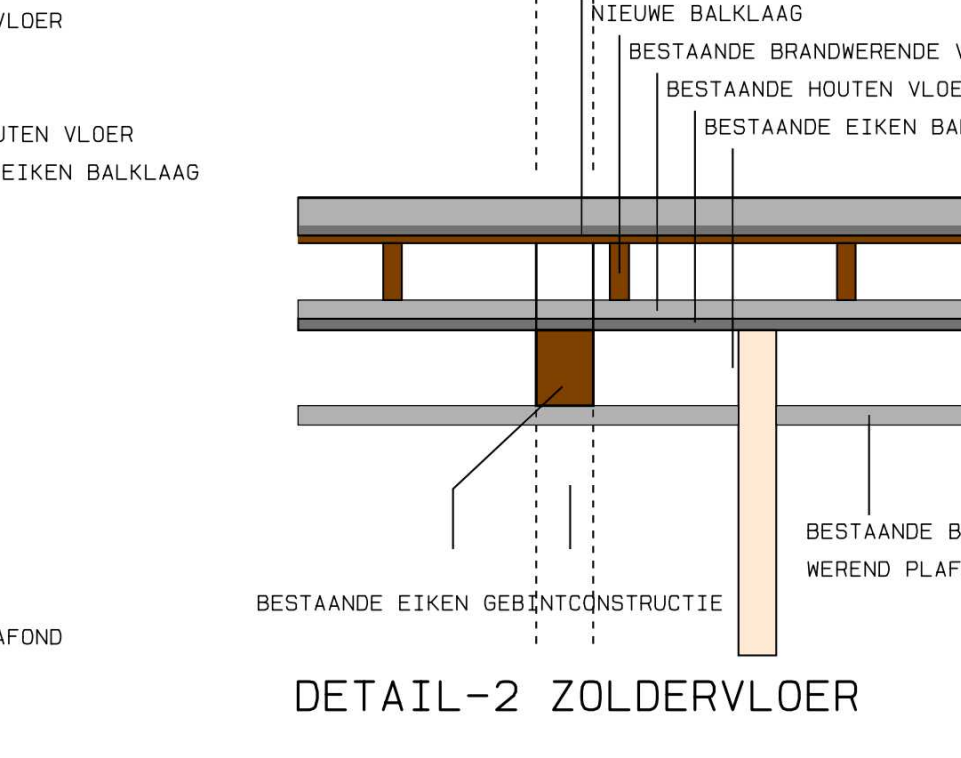

DWARSDOORSNEDE DG-DG

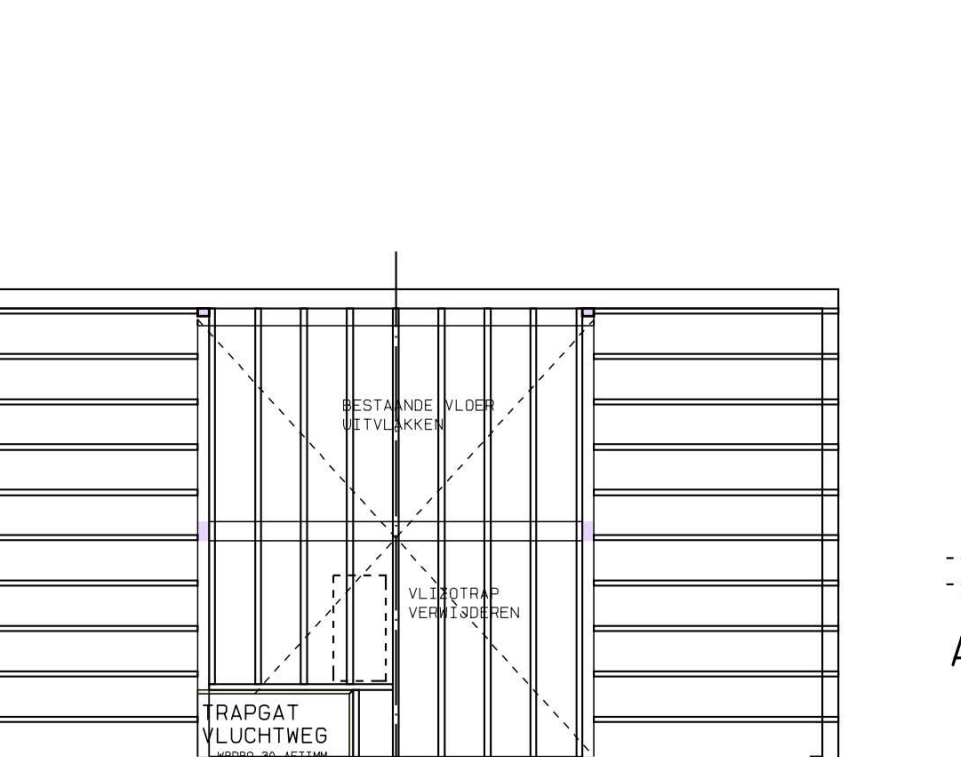

DWARSDOORSNEDE AB-AB

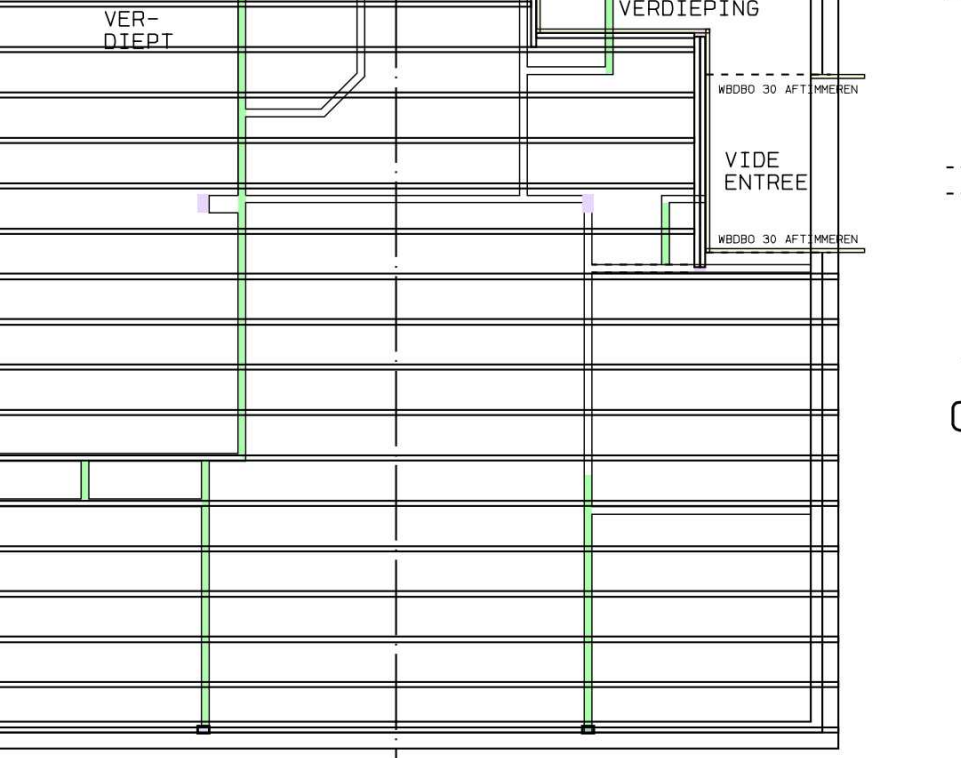

DWARSDOORSNEDE AG-AG

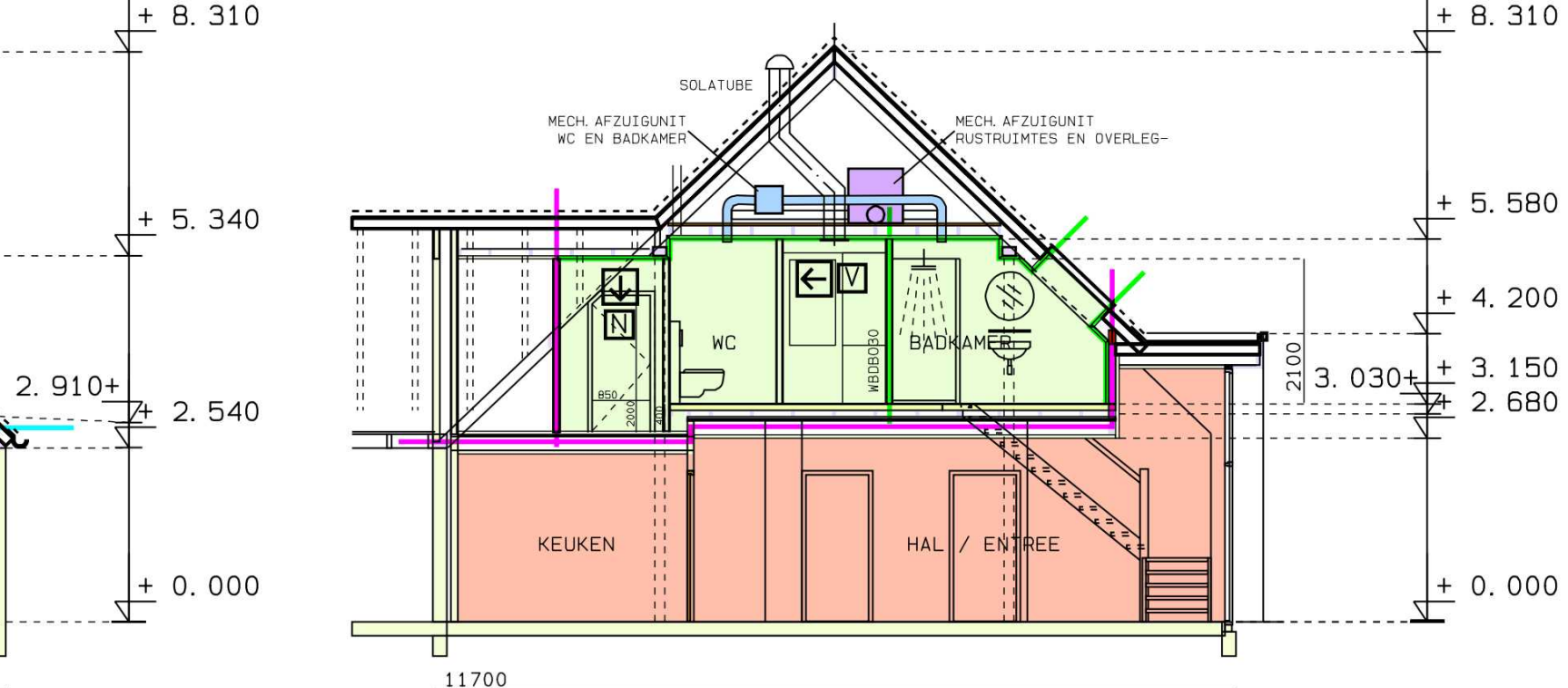

DWARSDOORSNEDE CB-CB

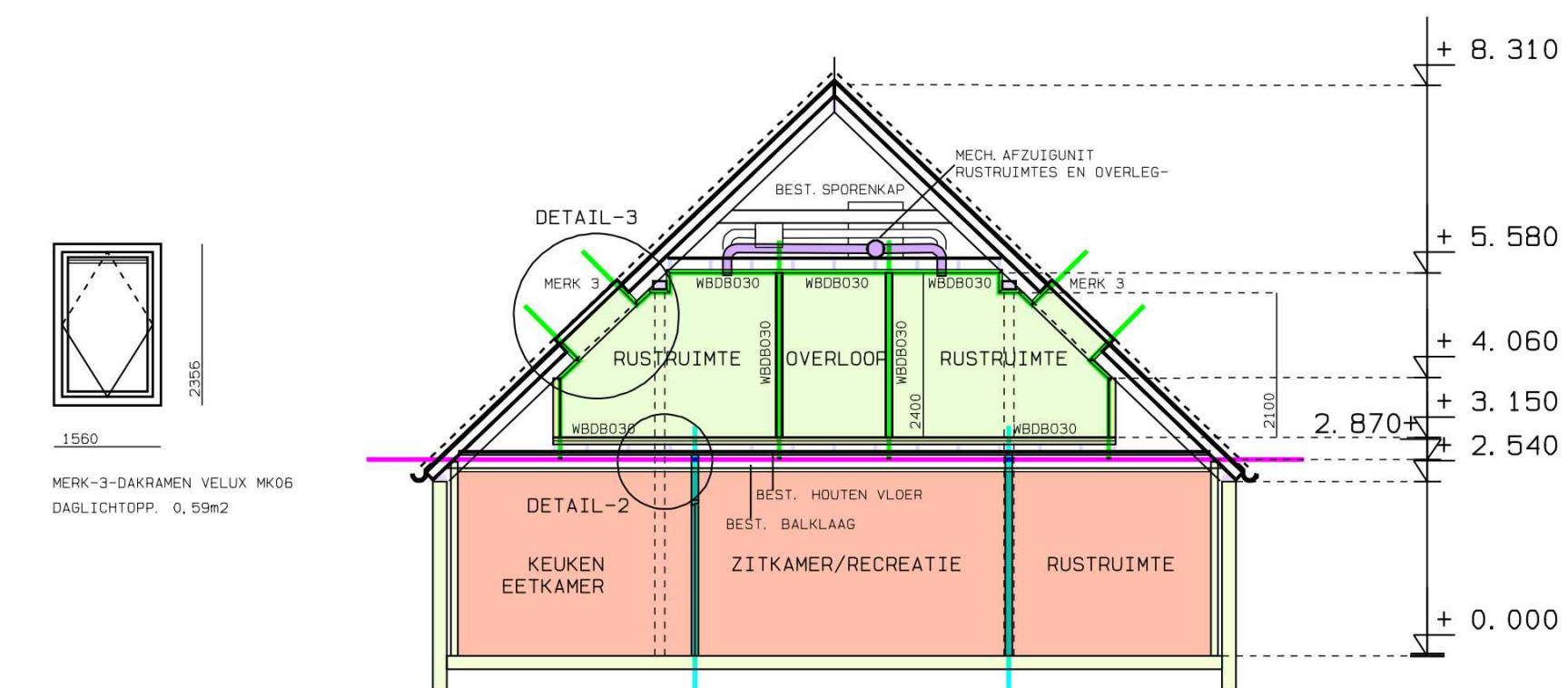

DWARSDOORSNEDE CG-CG

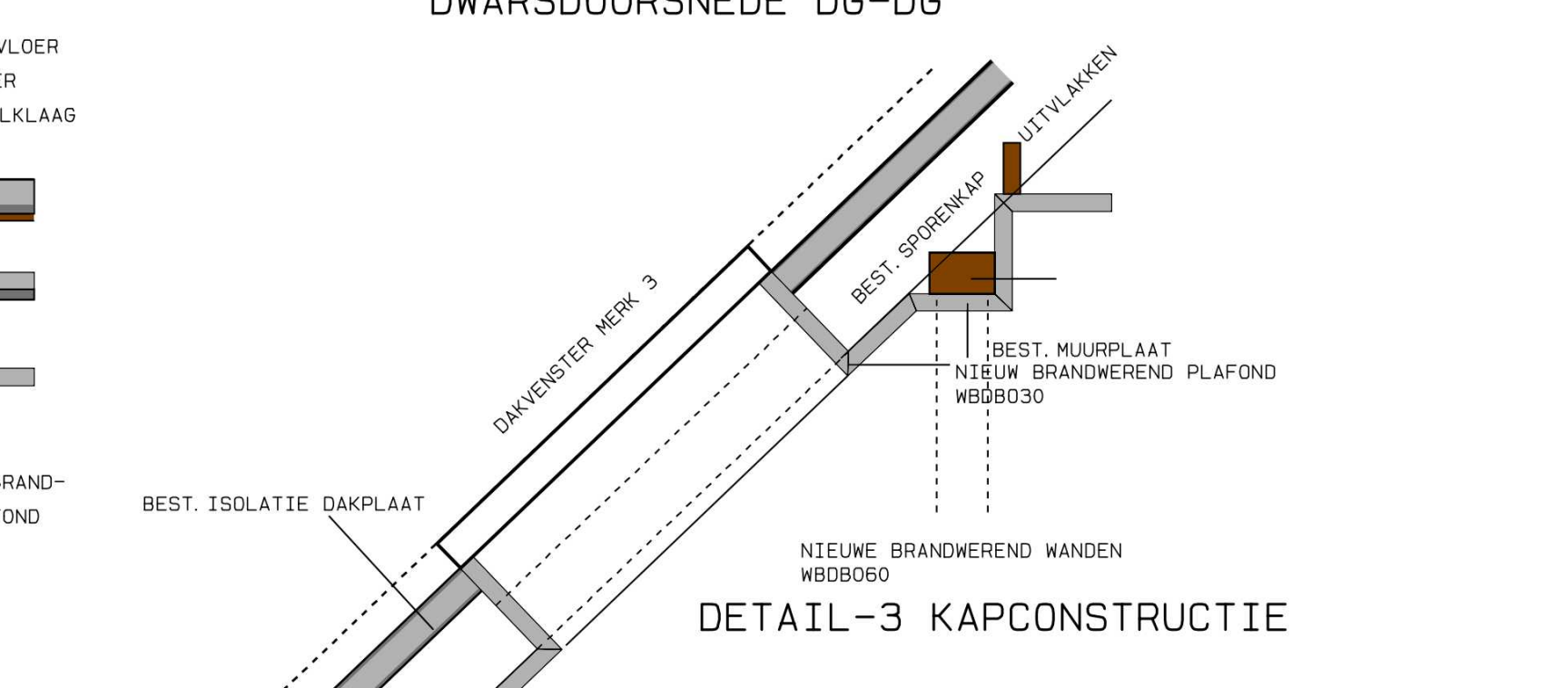

DWARSDOORSNEDE DG-DG

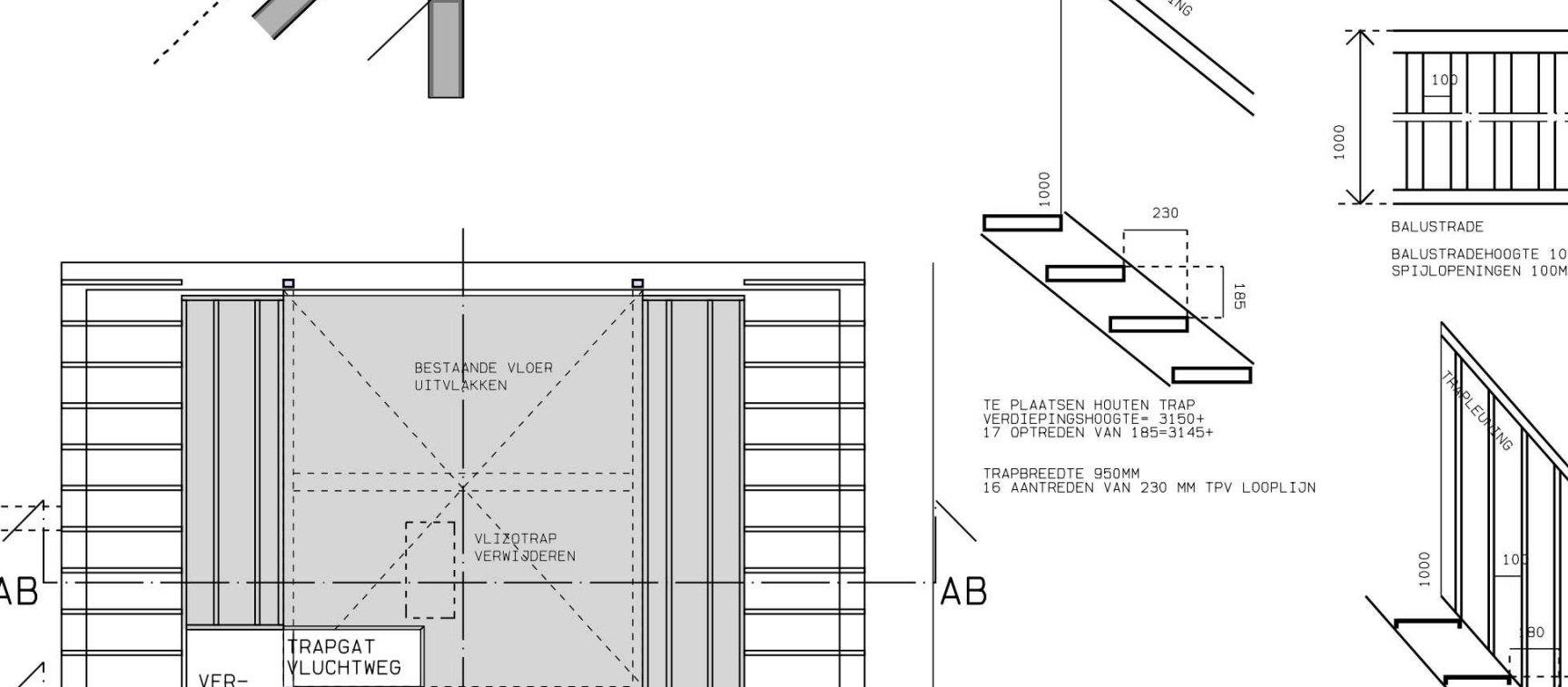

DWARSDOORSNEDE AB-AB

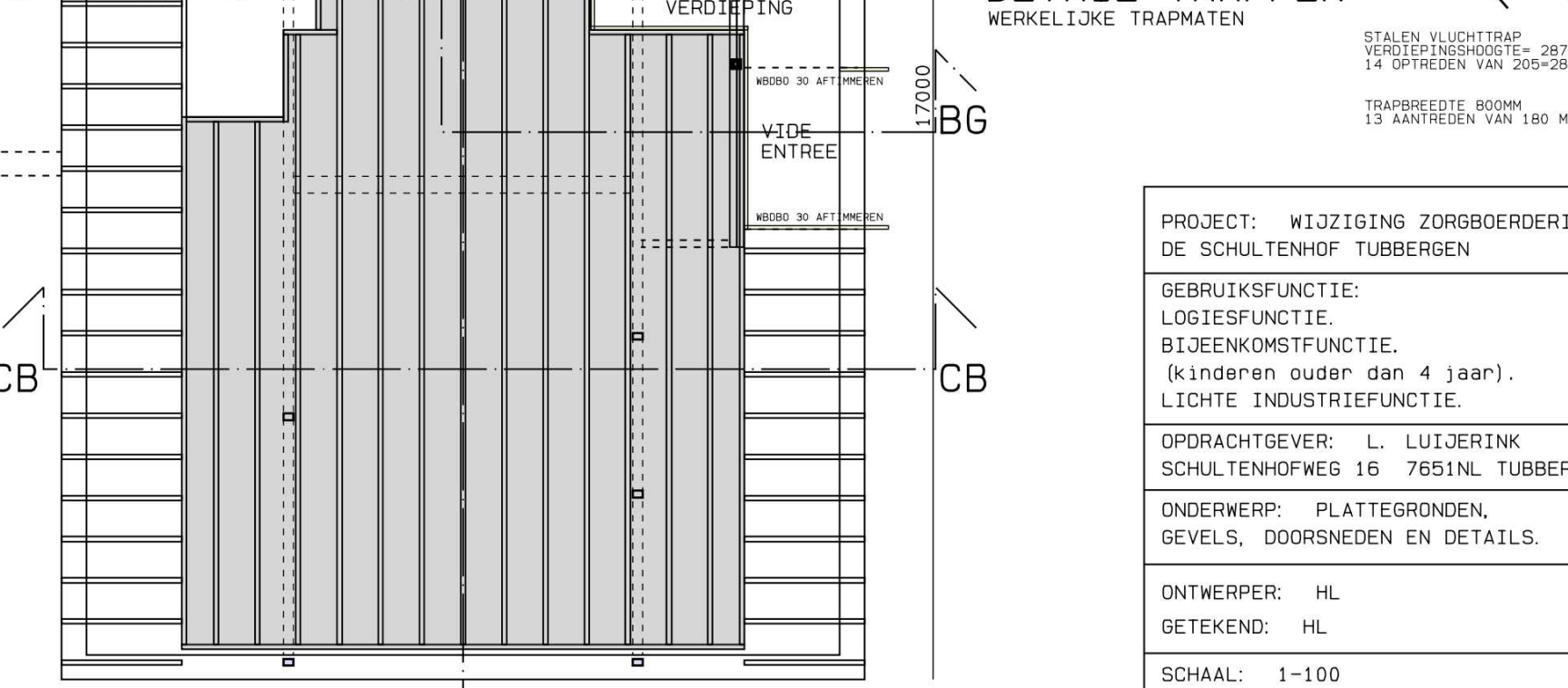

DWARSDOORSNEDE AG-AG

PROJECT: WIJZIGING ZORBEROERIJ...
OPDRACHTGEVER: L. LUIJTERINK...
SCHALTE: 1-100...
FORMAAT: A0...
DATUM: 2 OKT. 2023...
GEM1J2100: 26 APR. 2024...
14 JUNI 2024...
02 JULI 2024...
18 SEPT. 2024...
S-1